



Tris



SHELF
SUPPORTS





SYMBOLS AND FINISHES LEGEND

SYMBOLS

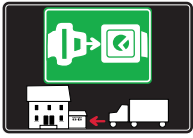

= SHELF SAFELY LOCKED DURING TRANSPORTATION AND AT HOME.



= ANTI-TURNOVER LOCKING SYSTEM



= NORMS / PATENTS



= PHILLIPS / POZIDRIV



= WITH BUFFER



= PART NO.



= BLADE SLOT



= WITH MAGNET



= PCS. PER PACKAGE



= COMBI SLOT



= NEWTON



= CAPACITY LOADING



= HEXALOBULAR SOCKET



= FRICTION



= WOOD / GLASS THICKNESS



= COUNTERSUNK HEAD



= AUTOMATIC



= HOLE DIAMETER



= PAN HEAD



= DROP DOWN



= DIAMETER



= FLANGE HEAD



= STANDARD HINGE



= LENGTH



= FLAT HEAD



= KIMANA HINGE



= HEIGHT



= TRILOBULAR SCREW



= FLAP HINGE



= RIGHT VERSION



= SELF-TAPPING SCREW



= WITH SPRING



= LEFT VERSION



= EURO THREAD



= WITHOUT SPRING



= SETTING CODE



= METRIC THREAD



= REVERSED SPRING



= PCS. PER PAD



= PRE-INSERTED SCREW



= PRE-INSERTED SCREW AND SPREADING BUSH



= CUT ON REQUEST



= SELF ADHESIVE



= WITH FLANGE

NOTE: Printing errors and omissions may exist despite our best efforts to ensure accuracy. We reserve the right to alter specifications without notice.

MATERIALS

ZA = Zinc Alloy	ST = Steel	HSS = High Speed Steel	BR = Brass	ABS = Acrylonitrile Butadiene Styrene
ZAnk = Nickel-plated Zinc Alloy	STzk = Zinc-plated Steel	AL = Aluminium	WD = Wood	EVA = Ethylene Vinyl Acetate

EP = ENGINEERING PLASTIC	+ EP = other engineering plastic available on request	SR = SOFT RUBBER	+ SR = other soft rubber available on request
----------------------------------------	--------------------------------------------------------------	--------------------------------	------------------------------------------------------

EPn = Natural Engineering Plastic	EPc = Clear Engineering Plastic	SRn = Natural Soft Rubber
EPw = White Engineering Plastic	EPg = Grey Engineering Plastic	SRw = White Soft Rubber
EPwg = Water Green Engineering Plastic	EPa = Anthracite Engineering Plastic	SRb = Black Soft Rubber

 FINISHES	+  = OTHER FINISHES AVAILABLE ON REQUEST
----------------------------------------------------------------------------------------------------	-------------------------------------------------------------------------------------------------------------------------------

PART NO.	FINISHES	PART NO.	FINISHES	PART NO.	FINISHES
00	Insignificant finish	IF	Middle Grey	RO	Red
AA	Natural	IJ	Light Grey	UT	T-Met 9007
AB	White	IL	Grey 20	UZ	T-Met
AE	White 9010	IN	Grey met. 26	WA	Bronzed
EA	Black	JB	Bright Aluminium	WI	Burnished
EC	Matt Black	JC	Aluminium - Chrome	XD	Satin-finished Steel
EE	Anthracite	JD	Matt Aluminium	YA	Nickel-plated
EW	Grey 9007	JE	Satin-finished Aluminium	YB	Bright Nickel-plated
FU	Gunmetal	JF	Aluminium - Brass	YC	Matt Nickel-plated
FV	Gunmetal V52	JG	Aluminium 5	YD	Satin-finished Nickel-plated
GR	Raw	JL	Aluminium PE 11	YQ	Black Nickel
HA	Brass-Plated	JM	Aluminium RAL 9006	Z9	Black Zinc
HH	Tropicalized	KA	Chrome	ZA	Zinc alloy
HL	Raw Brass	KB	Bright Chrome	ZN	Zinc-plated
HX	Graphite	KC	Matt Chrome	ZQ	Bright Gold
IA	Grey	LD	Brown 8019	ZY	Titanium
IB	Metallic Grey	NN	Metallic Beige	ZZ	Clear



TRIS



TRIS is the shelf support slotted into the shelf by making edge borings.

The sleeve of the shelf support can be expanded by inserting a pin (pin=optional extra), which improves the structural fastening of the shelf to the sides of the furniture. The shelf has to be pushed downwards onto the side brackets, which can be screwed into any position required. The side brackets slot into the socket of the shelf supports and a click locks the shelf in position.

The TRIS brackets are available in 3 different versions: with spreading bush and screw pre-inserted, and with hole for screw fixing, with pin Ø 5 only for 25 mm shelf thickness version.

TRIS is available for 19, 25, 28 and 30 mm shelf thickness.

18 mm min.

INSTALLATION AND ASSEMBLING

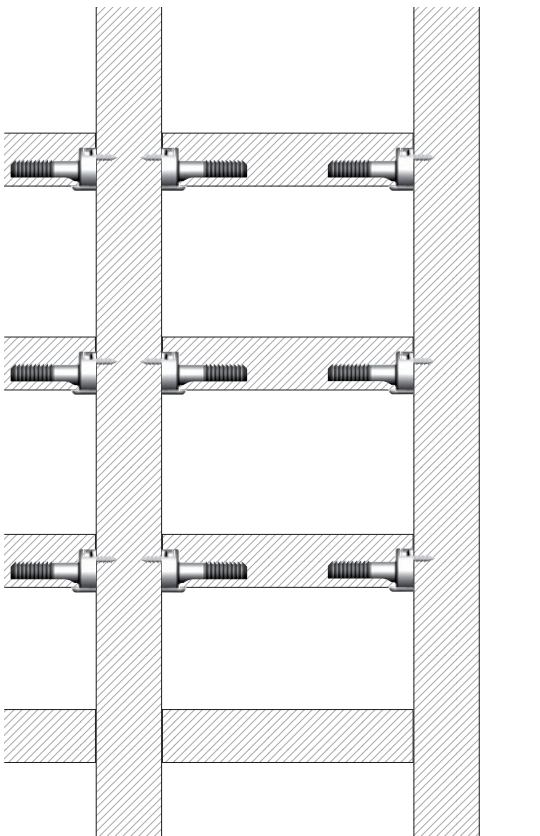
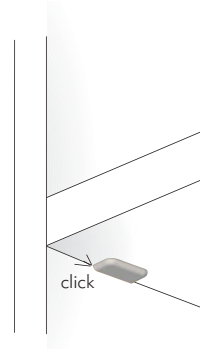
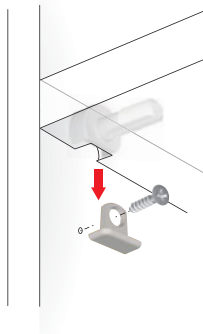
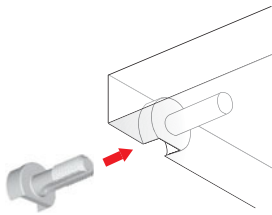

Assembling with alternative fixing options.

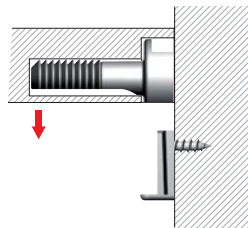

Assembling with pre-inserted spreading bush and screw to avoid hole damaging for shelf repositioning.

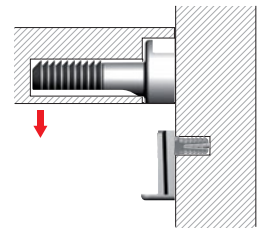

OPTIONAL FIXING:

to achieve much more horizontal connection fixing. The sleeve expands by inserting the provided Ø 3 mm pin.

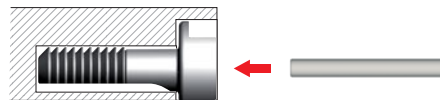



Also suitable for top and bottom panels when a back panel is used.



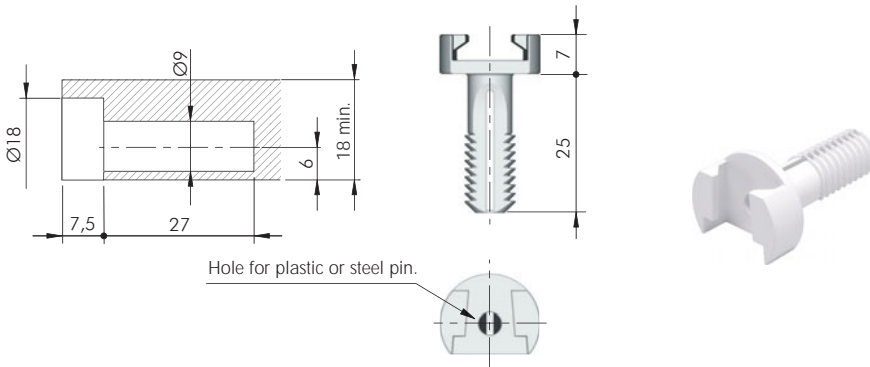



TRIS  **18 - 19 mm**



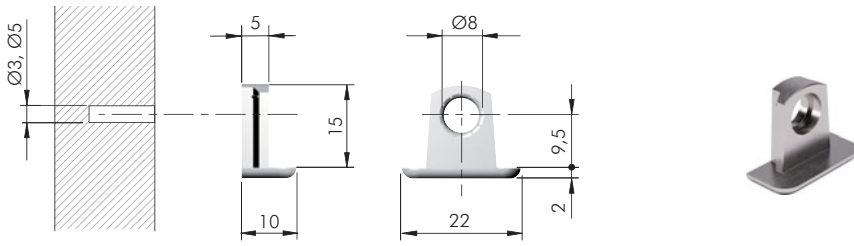

EP  = 5000 pcs.

  **10901010AB**





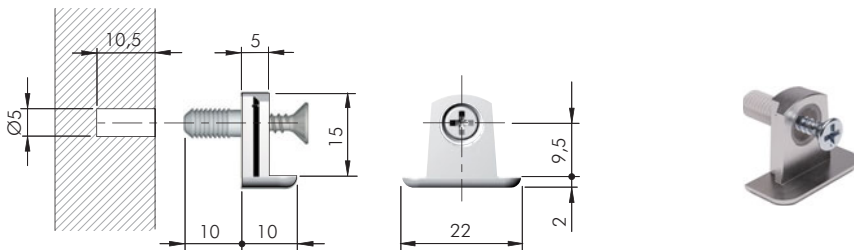

 = Ø 3, Ø 5 mm  + 

ZA  = 2500 pcs.



  **10902010YA**



 = Ø 5 mm  + 

  = PZ2



ZA ST EP  = 2500 pcs.

  **10902020YA**

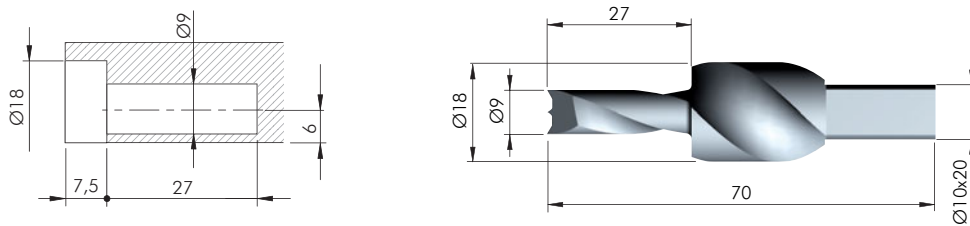
DRILL BIT FOR TRIS  **18 - 19 mm**



HSS  = on request



  **1090205000** 

1090206000 



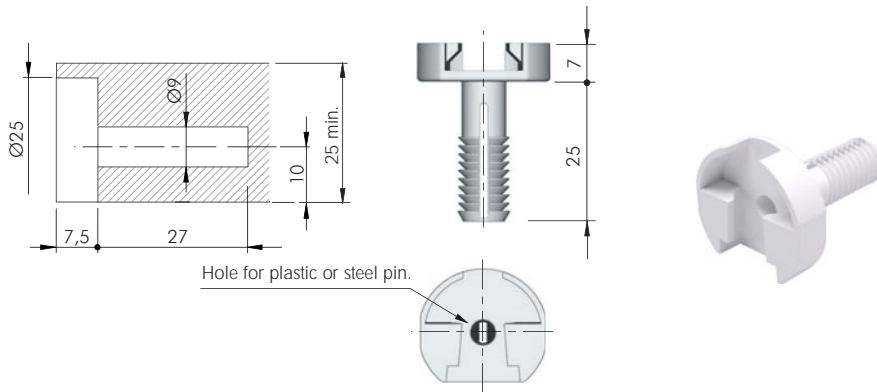



TRIS 25 mm

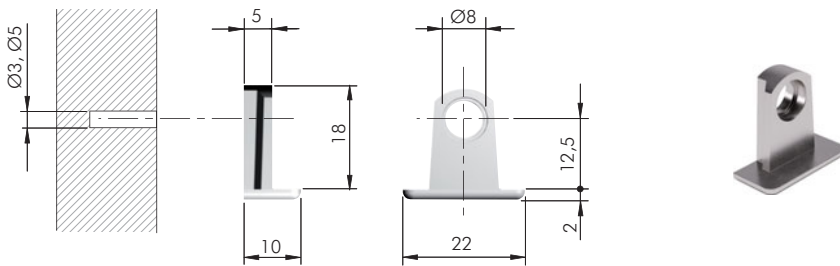





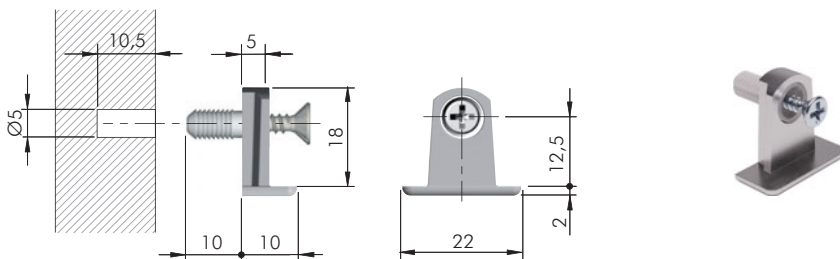

EP	 = 2500 pcs.
 123	
10901020AB	



 = Ø 3, Ø 5 mm	
ZA	 = 2500 pcs.
 123	
10903010YA	





 = Ø 5 mm	
  = PZ2	
ZA ST EP	 = 2500 pcs.
 123	
10903020YA	

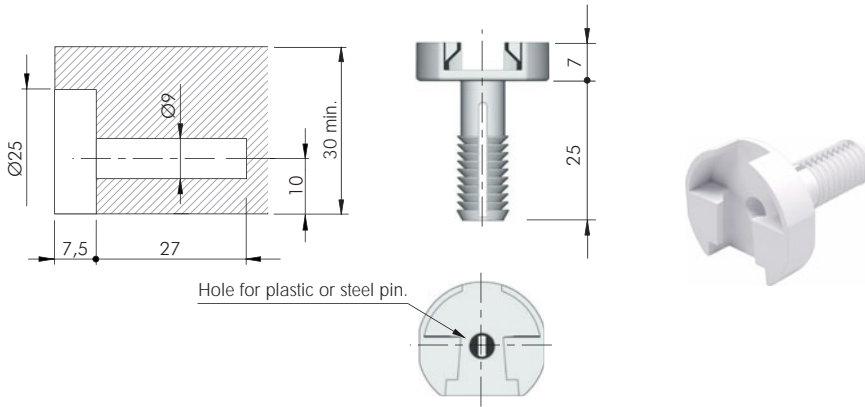

TRIS  **30 mm**







EP  = 2500 pcs.

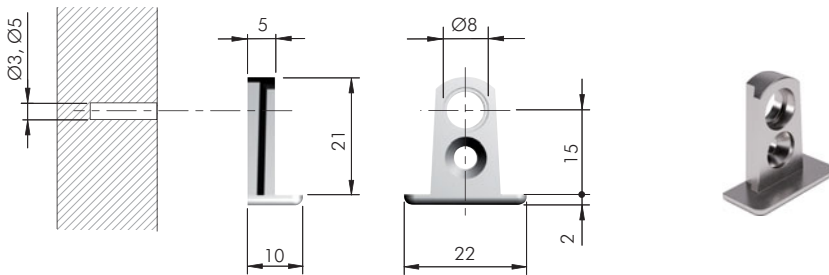

 

10901020AB







 = Ø 3, Ø 5 mm  + 

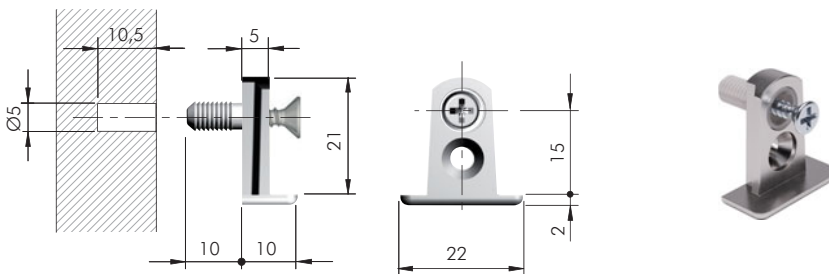

ZA  = 2500 pcs.

 



10905010YA



 = Ø 5 mm  + 

  = PZ2

ZA ST EP  = 2500 pcs.

10905020YA







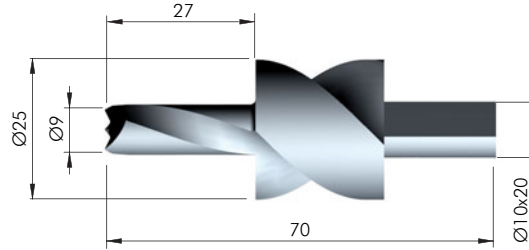
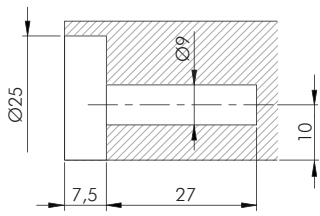

SHELF
SUPPORTS

TRIS

ITALIANA
ferramenta







DRILL BIT FOR TRIS 25, 28, 30 mm

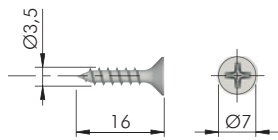







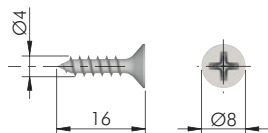

HSS	 = on request
 123	
1090207000	
1090208000	

TRIS FIXING ACCESSORIES



 = Ø 3 mm	
   = PZ2	
ST	 = 10.000 pcs.
 123	
60101390ZN	



 = Ø 3 mm	
   = PZ2	
ST	 = 5000 pcs.
 123	
60101570ZN	

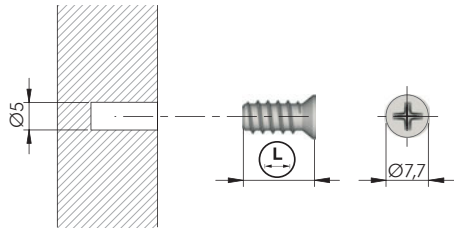

= Ø 5 mm +
 = PZ2
 = 5000 pcs.

123	L	
60502010ZN	10	
60501050YA	12,7	
60502020ZN	13	
60502030ZN	15	

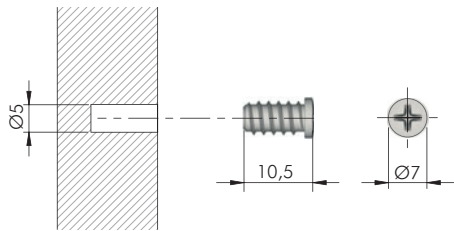

= Ø 5 mm +
 = PZ2
 = 5000 pcs.

123
60507010YA

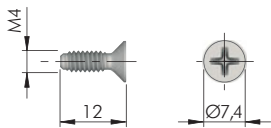

= M4 = PZ2
 = on request

123
60305040ZN

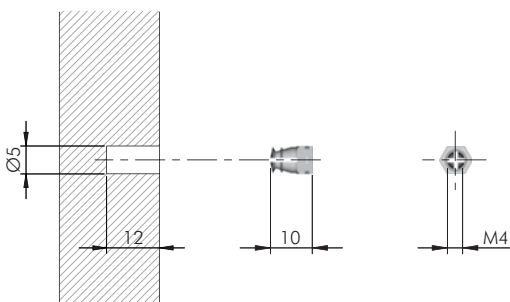

= Ø 5 mm = M4
 = 10.000 pcs.

123
20502021HL

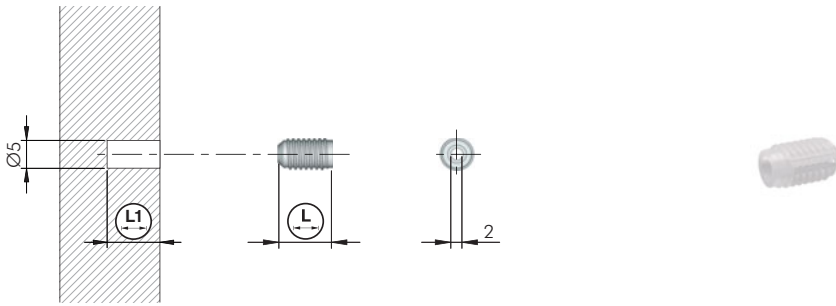

= Ø 5 mm

EPn = 10.000 pcs.

20302020AA		9,5	11,5
20302030AA		13	15

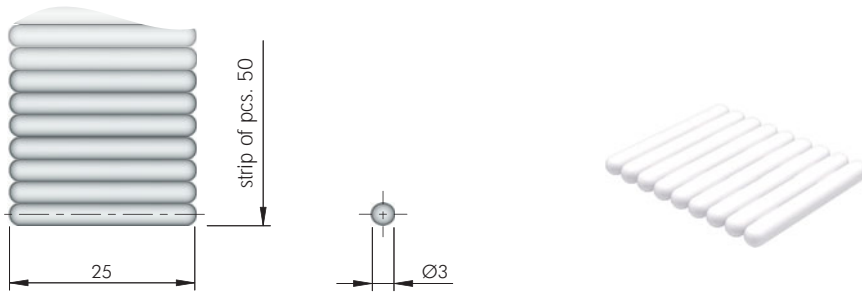

EP = 50.000 pcs.

10950010AB	
10950010EA	

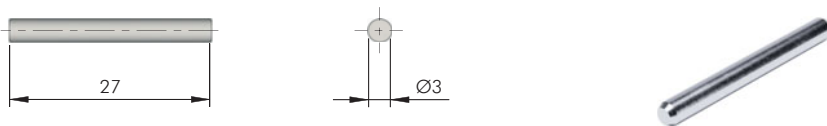

ST = 10.000 pcs.

10951010ZN	



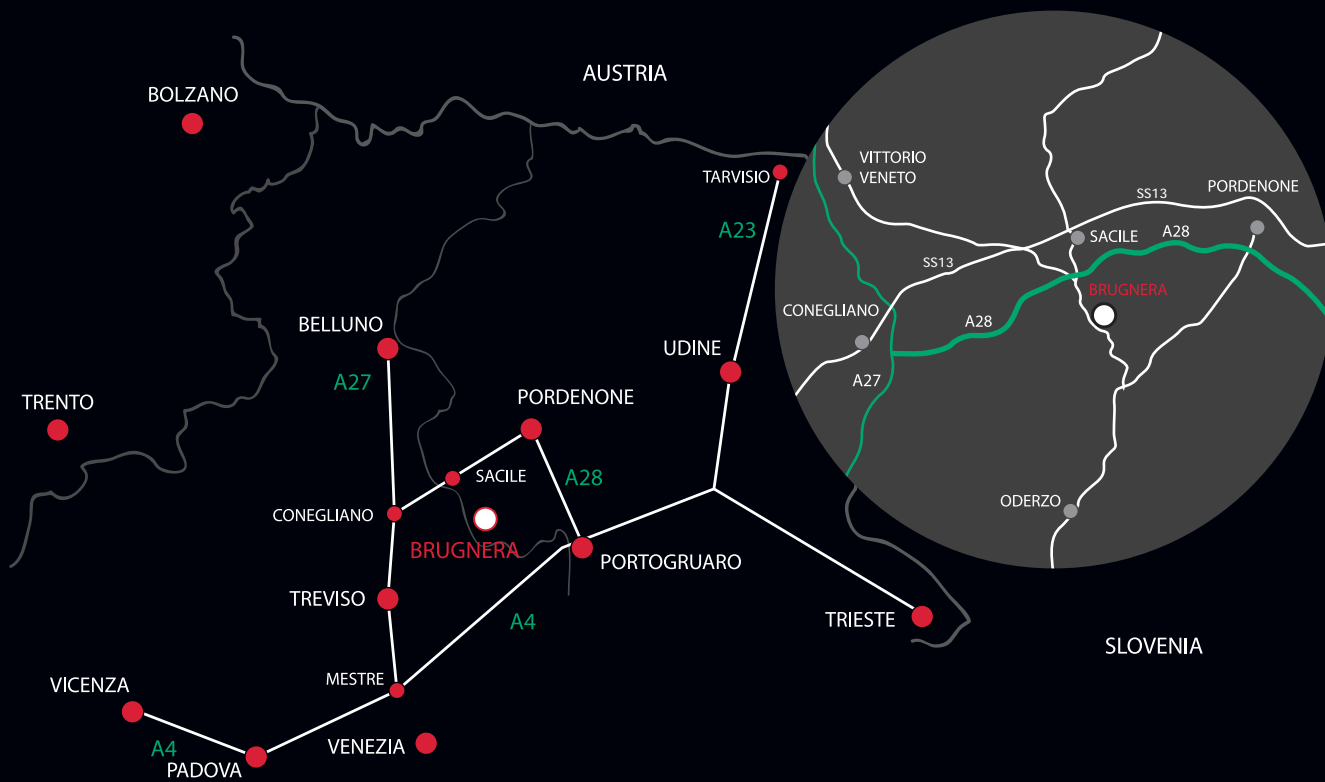

www.italianaferramenta.it